

Yamato[®]

GT SERIES

OVERLOCK/SAFETY STITCH MACHINE

***YAMATOG-Series Can Obtain Well-balanced
Stitch Formation and Can Meet Wider Range
of Sewing Conditions Quickly and Easily.
Besides, YAMATO "Non-stain" Technology Is
Introduced for Further Enhanced Quality and
Minimized Production Downtime.***

***YAMATOG-Series Is Your Best Partner for
Further Prosperity.***



ISO9001:2000
JQA-QM6412

Submodel

Seam	Model	Description									
Overlock Machines											
For Blind Hemming and General Seaming (with Hemming Guide)											
	AZ8000G	For blind hemming and general seaming With Hemming Guide. Lower Feed.	1	3	-	4	6	23.7	8,000		
	AZF8000G	Same as AZ8000G, except with Top Feeder to prevent ply shift.	1	3	-	4	7	25.7	6,500		
For 1 Needle General Seaming											
	AZ8003G-8	For knitted material. Lower Feed.	1	3	-	3, 4	6	23.7	8,000		
	AZF8003G	Same as AZ8003G, except with Top Feeder to prevent ply shift.	1	3	-	4	7	25.7	6,500		
For 2 Needle General Seaming											
	AZ8020G-8	For knitted material. Lower feed.	2	4	2.0, 2.4	4, 5, 6	6	23.7	8,000		
	AZ8062G	Same as AZ8020G, except with Floating Presser Foot.	2	4	2.4	5	5	23.7	7,000		
	AZF8020G	Same as AZ8020G, except with Top Feeder to prevent ply shift.	2	4	2.0, 2.4	4, 5, 6	7	25.7	6,000		
	For Wider Overlock Seam Width (Maximum 8mm)										
	AZ8120G-8	For wider overlock seam width. Lower Feed.	2	4	2.0, 2.4	5, 6, 8	7	25.7	6,000		
	AZF8120G	Same as AZ8120G, except with Top Feeder to prevent ply shift.	2	4	2.4	5, 6, 8	7	25.7	6,000		
For Tricot and Light Weight Material											
	AZ8039G	With special gauge parts to prevent tunnel seaming.	2	4	2.4	5	6	23.7	8,000		
	AZ8069G-8	Same as AZ8039G, except with Floating Presser Foot.	2	4	2.4	5	5	23.7	7,000		
For Inserting Reinforcing Tape											
	AZ8025G-8	With Presser Foot for inserting tape. Lower Feed	2	4	2.4	5	6	23.7	8,000		
	AZF8025G	Same as AZ8025, except with Top Feeder to prevent ply shift.	2	4	2.0, 2.4	4, 5, 6	7	25.7	6,500		
	For Wider Overlock Seam Width (Maximum 8mm)										
AZ8125G-8	For wider overlock seam width. Lower Feed.	2	4	2.4	5, 6	7	25.7	6,000			
For Rolled-hemming of Handkerchief, Scarf, etc.											
	AZ8016G	For narrow seam width(2mm) rolled hemming. With Interchangeable Stitch Plate Tongue and rubber coated Feed Dog.	1	3	-	2	3	23.7	8,000		
For Piping with Cord.											
	AZF8026G	With Top Feeder to prevent ply shift and twisting of tape.	2	4	2.4	5, 6	7	25.7	6,500		
2 Needle Seaming for Heavy Knitted Material											
	AZ8032G	With high stroke Upper Looper. Lower Feed.	2	4	2.0, 2.4	5	7	25.7	7,000		
	AZ8035G	Same as AZ8032, except with Presser Foot for inserting tape.	2	4	2.4	5, 6	7	25.7	7,000		
For Serging and Top Stitching with Hemming											
	AZ8022G	Serging and top stitching with hemming in one operation. Lower Feed. Stitching width: 2mm -5mm	2	4	3.2	6	4.5	23.7	6,500		

Seam	Model	Description								
Safety Stitch Machine										
For General Seaming										
	AZ8500G	For woven material. Lower feed	2	5	3.2, 5.0	4, 5, 6	6	23.7	7,500	
	AZF8500G	Same as AZ8500G, except with Floating Foot.	2	5	2.4, 3.2, 5.0	4, 5, 6	7	25.7	6,500	
	AZFR8500G	With Top Feeder to prevent ply shift, and Front of Needle and Rear of Presser Foot	2	5	5.0	5	7	25.7	6,500	
	AZ8560G	Same as AZ8500G, except with Presser Floating Foot.	2	5	3.2, 5.0	4, 5	3	23.7	6,500	
Multi-purpose 3 Needle Safety Stitch (For 2 or 3 Needle Safety Stitch and 1 or 2 Needle Overlock)										
	AZ8520G	For woven and knitted material. Lower Feed.	3	6	3.2-2.4	5, 6	5.5	23.7	7,500	
	AZF8520G	Same as AZ8520G, except with Top Feeder to prevent ply shift.	3	6	3.2-2.4 5.0-3.2	6, 7, 8	6.5	25.7	6,500	
For Gathering (Ruffing)										
	AZ8505G	With Separator Blade for gathering. Lower Feed	2	5	3.2, 5.0	4, 5	5.5	23.7	7,000	
For Heavy Weight Material (with Tractor Type Presser Foot)										
	AZ8600G	For side seaming on Jeans etc. Lower feed	2	5	5.0	5, 7	7.5	27.1	6,500	
	AZF8600G	Same as AZ8600G, except with Top Feeder to prevent ply shift.	2	5	5.0	5, 7	7.5	27.1	6,000	
Multi-purpose 3 Needle Safety Stitch for Heavy Weight Material (with Tractor Type Presser Foot)										
	AZF8620G	Multi-purpose for jeans application. With Top Feeder to prevent ply shift.	3	6	5.0-3.2	7	7.5	27.1	6,000	
For Attaching Zipper Tape										
	AZF8611G	For heavy weight material. With Top Feeder to prevent ply shift and Zipper Tape Guide.	2	5	5.0	5	6.5	27.1	6,000	
For Binding Pocket Bag										
	AZR8920G	2 Needle Double Chain Stitch Binding Machine. With Top Feed Behind Presser Foot	2	4	5.0	-	3.5	25.7	6,500	

Top Feeder for Further Enhanced Quality and Applicability for Different Sewing Conditions



High Quality Finish

It eliminates damages on light or delicate fabrics, without ply shift even on all fabrics hard to feed. Also, curved sewing operations can be easily done.

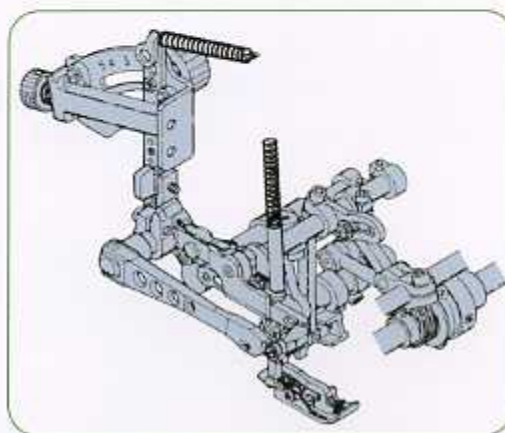

Higher Productivity

For gathering and heavy weight material, upper and lower feeder enables easy and beautiful performance with high speed.

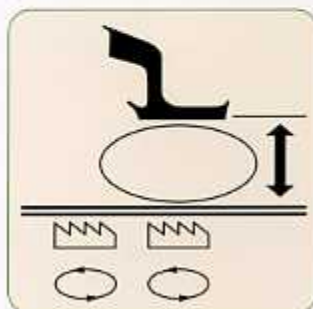

Feed dogs of upper and lower makes the perfect path to feed the fabric securely. Height and locus of top feeder can be easily adjusted depending on the thickness of material to be sewn.



Simple Release Presser Foot System

Top Feeder machine of G series is equipped with simple release presser foot system, which can lift up the top feed dog by locking lever with one hand.

■ Device For AZF-G series

TG: Top Gathering Controller (For AZF-G series)

On the conventional lower feed sewing machines, it was difficult for operators to observe the gathering condition because the gathering is made on lower ply of fabrics. However, on upper and lower differential feed machines, the gathering can be made on upper feeding so that the sewing becomes very easy and beautiful performance can be obtained without slow-down of sewing speed.

SG: Intermittent Gathering Controller

This is used for intermittent gathering operation for AZF-G series machines with TG (Top Gathering Attachment). According to the amount of gathering can be set stopper at suitable position.

SG-M : Solenoid type

SG-A : Air-operated Type

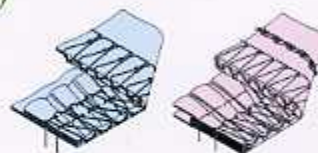

As Overlock / Safety Stitch Machines Are the Very Basic Equipments in Sewing Room, **YAMATO G Series** Is Designed to Be Stable in Performance and Flexible in Application, and Help You Get Yourself Ready for Meeting Tough and Various Requirements from Your Clients.



Gseries



Needle Thread Take-up Mechanism Activated by Upper Knife

Looper thread take-up mechanism co-operating with looper timing produces straight and stretchable soft-chain with balanced stitch formation.



Ideal Stitch Performance

You can obtain neatly tightened and highly durable finish. Soft and elastic seam is also available as the stitch is formed without stress on each thread.



Easy to See The Sewing Area

It is easy for operators to see the sewing area and this feature improves sewing performance.

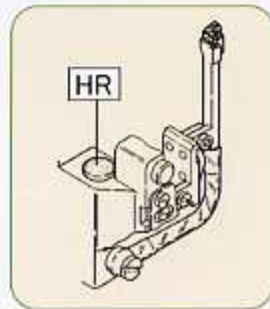

HR Needle Cooling Device is Now Build-in.

Sealed compact design needle cooling device eliminates dust or alien substance, as the result it ensures constant cooling of needle.

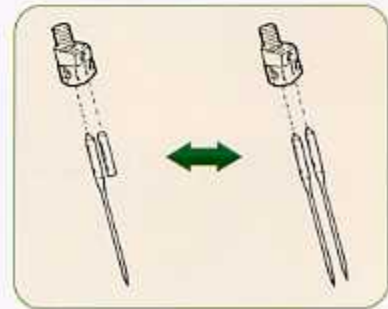

Equipping Needle Clamp for 2 Needle Specifications as Standard

Needle clamp for 2 needle specifications is equipped even on single needle model. Therefore, change-over from single needle use to 2 needle use can be easily provided.

Floating Foot

It prevents twisting and slippage during sewing on a wide range for various kind and weight of materials.

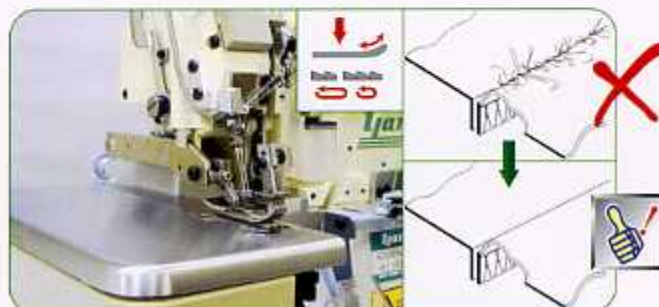

"Non-stain(PAT.P)" technology is introduced to minimize oil stains on your products.

"Non-stain(PAT.P)"



While giving enough lubrication for the internal driving mechanism, Yamato exclusive sealing system prevents the oil from coming to the sewing area through moving parts. This feature minimizes the risk of oil stain, one of the most frequent causes of defects.

- Saving -"Non-stain" increases productivity.

"Non-stain" finish minimizes your loss, such as downtime and extra cost caused by spot removing operations.

- Good performance and long life- durable machines

Yamato "Non-stain" technology will not sacrifice the performance and the durability of machines, but keep the machine running smoothly at high speed (8000 s.p.m.max) for long life.

(*Depending on the frequency of use)

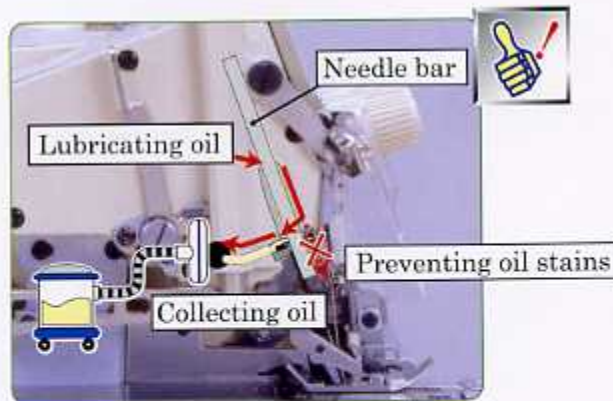

Further alternative in enhancement of quality and improvement of working environment

SC10: Self Cleaning System (options)



- It eliminates accumulating of dust around the lower knife and the area under stitch plate and ensures clean operation environment.

- It prevents oil-stained lint from jumping on the work : another cause of oil stain.

➔ Blowing off lint
(uses a oil cooling fan which cools off oil).

➔ Collecting lint
(for lint collection, an optional vacuum cleaner is recommended).



■ Numbering of Model

AZ(F)8020G-Y5DF-8/K2

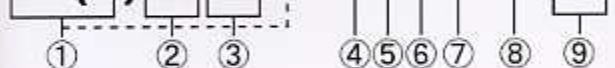

- ① Symbol of series: AZ=Lower feed, AZF: Direct Drive Variable Top Feeder (front of needle) ② Class No.: 80=Overlock 85=Safety stitch ③ Submodel
 ④ Needle Distance: 0= Single needle, X=2.0mm, Y=2.4mm, A=3.2mm, C=5.0mm
 ⑤ Overedge seam width: 2=2mm 4=4mm 5=5mm 6=6mm
 ⑥ Feeding mode: D= Differential Feed ⑦ Type of Upper Knife: F=Flat Knife (Standard) ⑧ Special Specification ⑨ Devices

■ Specification of AZ-G series

Class	AZ8000G	AZ8500G	AZ8600G
Name	Overlock Machine	Safety Stitch Machine	Safety Stitch Machine for Heavy Weight Material
Sewing Speed*	8,000s.p.m. max	7,500s.p.m. max	6,500s.p.m. max
Adjustment of Stitch Length	Pushbutton System		
Stitch Length	1.0mm~4.0mm		2.0mm~5.0mm
Feeding Mode	Differential Feed		
Adjustment of Feeding Mode	Lever (With Micro Adjuster)		
Differential Feed Ratio	1: 0.7~1: 2.3 (At Shipment) 1: 0.6~1: 2.0 (Available by adjusting the position of main feed dog lever pin) 1: 1.0~1: 3.0 (Available by adjusting the position of main feed dog lever pin)		
Needle Bar Stroke	Standard: 23.7mm AZ8120G only: 25.7mm	Standard: 23.7mm	Standard: 27.1mm
Needle Type	DC×1	DC×27 (Both right and left)	DO×5 (Both right and left)
Presser Foot Lift	Standard: 6.0mm AZ8120G only: 7.0mm AZ8016G only: 3mm Floating Presser Foot Type: 5mm	Standard: 6.0mm AZ8520G, 25G only: 5.5mm AZ8505G only: 5.5mm Floating Presser Foot Type: 3mm	Standard: 7.5mm

* Depending on submodels and sewing condition.

■ Specification of AZF-G series

Class	AZF8000G/AZF8500G	AZFR8000G/AZFR8500G	AZR8900G	AZF8600G	AZFR8600G
Name	Overlock/Safety Stitch Machine with Variable Top Feeder		Double Chain Stitch Machine with Variable Top Feeder	Safety Stitch Machine with Variable Top Feeder for Heavy Weight Materials	
Top Feed Dog(s)	Front of Needle	Front of Needle and Rear of Presser Foot	Rear of Presser Foot	Front of Needle	Front of Needle and Rear of Presser Foot
Top Feeder	Front of Needle	●	●	●	●
	Rear of P. F.	X	●	X	●
Adjustment of Top Feed	Lever (With Micro Adjuster)				
Sewing Speed*	6,500s.p.m. max	5,500s.p.m. max	6,500s.p.m. max	6,000s.p.m. max	5,500s.p.m. max
Adjustment of Stitch Length	Pushbutton System				
Stitch Length	1.0mm~4.0mm			2.0mm~5.0mm	
Feeding Amount of Top Feed Dog	10.0mm (max.)	7.0mm (max.)	10.0mm (max.)	7.0mm (max.)	7.0mm (max.)
Up and Down Movement of Top Feed Dog	5.0~8.0mm	3.5mm~6.0mm	5.0~8.0mm	3.5~6.0mm	3.5~6.0mm
Lifting Amount of Top Differential Feed Dog	8.0~8.5mm	7.0mm~7.5mm	8.0~8.5mm	7.0~7.5mm	7.0~7.5mm
Lower Feeding Mode	Differential Feed				
Adjustment of Differential Feeding Mode	Lever (With Micro Adjuster)				
Differential Feed Ratio	1: 0.7~1: 2.3 (At Shipment) 1: 0.6~1: 2.0 (Available by adjusting the position of main feed dog lever pin) 1: 1.0~1: 3.0 (Available by adjusting the position of main feed dog lever pin)				
Needle Bar Stroke	25.7mm	25.7mm	25.7mm	27.1mm	27.1mm
Needle Type	DC×27 AZF8000G only: DC×1	DC×27 (Both right and left)		DO×5 (Both right and left)	
Presser Foot Lift	7.0mm	6.0mm	5.5mm	7.5mm	6.0mm

* Depending on submodels and sewing condition.



AZ-G series



AZF-G series

YAMATO SEWING MACHINE MFG. CO., LTD.
<http://www.yamato-sewing.com>

HEAD OFFICE
 4-12, 4-CHOME, NISHI-TENMA, KITA-KU, OSAKA, 530-0047, JAPAN
 TEL:+81-6-6364-5621 / FAX:+81-6-6364-7165
 / E-mail: export-dept@yamato-sewing.com

YAMATO U.S.A. INC.

YAMATO EUROPE GmbH.

YAMATO (HONG KONG) CO., LTD.

YAMATO (香港) 有限公司 东莞代表处

大和缝纫机(宁波)有限公司

大和缝纫机制造株式会社 青岛事务所

大和缝纫机制造株式会社 上海事务所

YAMATO SINGAPORE PTE LTD.

YAMATO SINGAPORE PTE LTD, INDIA LIAISON OFFICE, TIRUPUR MAIN BRANCH TEL:+91-421-533701 / FAX:+91-421-2235822 / E-mail: yamato-sewing@eth.net

YAMATO SINGAPORE PTE LTD, INDIA LIAISON OFFICE, DELHI BRANCH TEL:+91-11-5160-3280 / FAX:+91-11-5160-3281 / E-mail: yamatonorthind@sify.com

YAMATO MEXICO OFFICE

TEL:+1-803-548-0334 / FAX:+1-803-548-0405

TEL:+49-40-356347-0 / FAX:+49-40-354371 / E-mail: sales@yamato.de

TEL:+852-2721-0251 / FAX:+852-2723-0444 / E-mail: yamato@yamato-sewing.com.hk

TEL:+86-769-6231363 / FAX:+86-769-6231362

TEL:+86-574-86800518, 86800558 / FAX:+86-574-86800555 / E-mail: yamato@yamato-china.net

TEL:+86-532-5783175 / FAX:+86-532-5783172

TEL:+86-21-64400017, 64400019 / FAX:+86-21-64400021

TEL:+65-6287-1955 / FAX:+65-6287-1028 / E-mail: sales@yamato-sewing.com.sg